



# LA ESCONDIDA

HIDDEN LAND

---

CORASOL, RIVIERA MAYA

An aerial photograph of a tropical resort. In the foreground, a circular swimming pool with a thatched-roof cabana is situated on a sandy area. The pool is surrounded by numerous palm trees. To the right, a sandy beach meets the turquoise ocean. Several lounge chairs and umbrellas are scattered on the beach. The text "LIVE THE RIVIERA MAYA" is overlaid in the upper center of the image.

LIVE THE RIVIERA MAYA

CARIBBEAN SEA

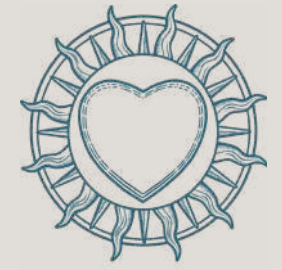

CORASOL

-  GOLF COURSE
-  LAKE

- 1** LA ESCONDIDA
- 2** THE PARK
- 3** PUNTA LAGUNA
- 4** PALM VILLAS
- 5** THE VILLAGE
- 6** GRAN COYOTE CLUB HOUSE
- 7** EL AMATE
- 8** COSTA RESIDENCES & BEACH CLUB
- 9** DOWNTOWN CORASOL
- 10** CONDOMINIUM BEACH ACCESS
- 11** 5TH. AVENUE ACCESS



MAIN  
ACCESS



MAIN ENTRANCE CORASOL

## FALL IN LOVE WITH CORASOL

Corasol is nestled along a pristine stretch of Riviera Maya coastline, offering a new definition of resort living and property ownership, masterfully integrated into the landscape by renowned architects Sordo Madaleno and CUAIK. With immaculate white-sand beaches, serene lagoons, and a lush valley of native jungle flora, this exclusive gated residential community offers privacy on the Caribbean Sea, featuring six distinct architectural options: Costa Residences, The Village, Palm Villas, La Escondida, Punta Laguna, and El Amate.





# LIVE LA ESCONDIDA

The images shown are for illustrative purposes only. The final product may vary and is subject to change without prior notice, based on the needs of the project and the developer.

## LA ESCONDIDA: WHERE GOLF MEETS THE SEA

Nestled in Corasol's privileged jungle, you'll find 46 exclusive single-family lots ranging from 390 m<sup>2</sup> to 909 m<sup>2</sup>. Each lot offers unparalleled views of the Gran Coyote golf course and the surrounding jungle landscape.

La Escondida offers you the opportunity to create the perfect home in an exclusive and serene setting.



THE PROJECT

- A. GATED ENTRY
- B. PLAYGROUND
- C. DIRECT ACCESS TO THE GOLF COURSE

HOLE 3

HOLE 4



The images shown are for illustrative purposes only. The final product may vary and is subject to change without prior notice, based on the needs of the project and the developer.

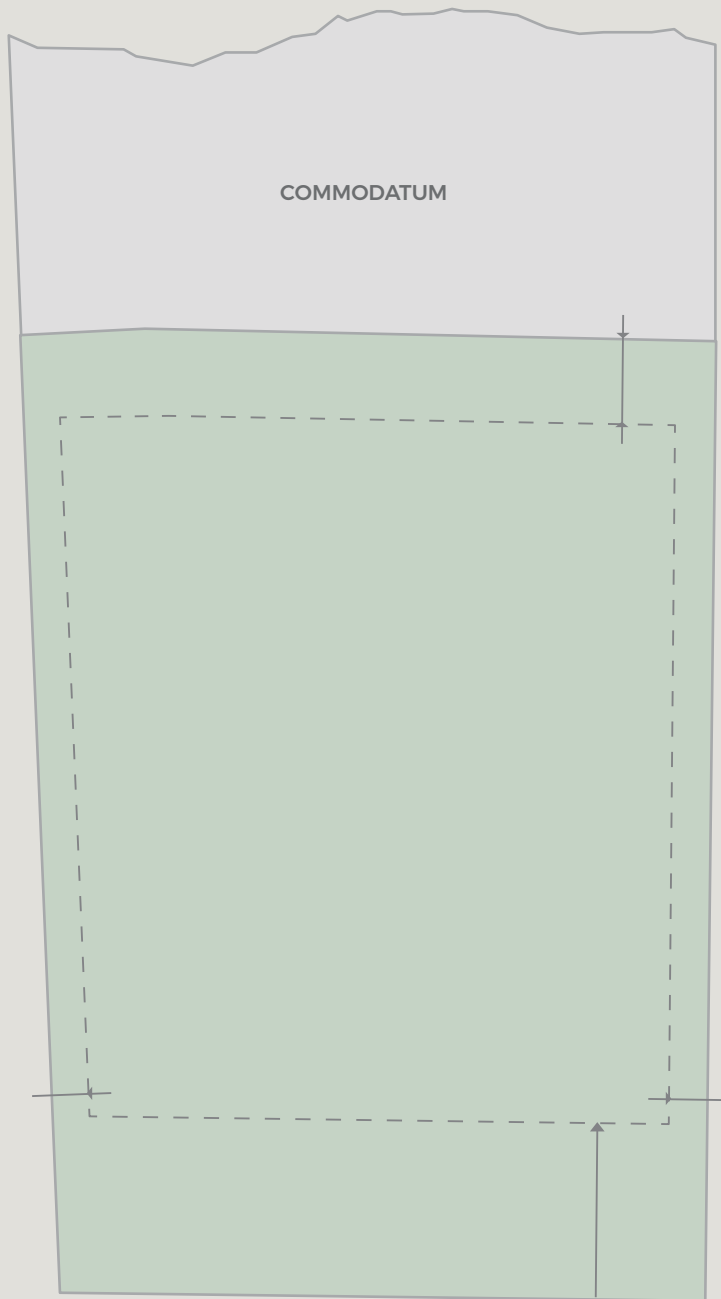

COMMODATUM

FRONT

## REFERENCE LOT PLAN

Your lot in **La Escondida** is designed to offer privacy and a natural environment, with spacing between lots. Additionally, you must leave a setback on each side between your construction and the edge of your property, thus creating a natural barrier between lots. To maintain the balance and harmony of the development, you must also leave space at the front and back of your property.

Furthermore, your lot includes a commodatum related to the golf course. Although this area is not deeded property, you are permitted to use it according to the rules established by the condominium.

## LOT DETAILS

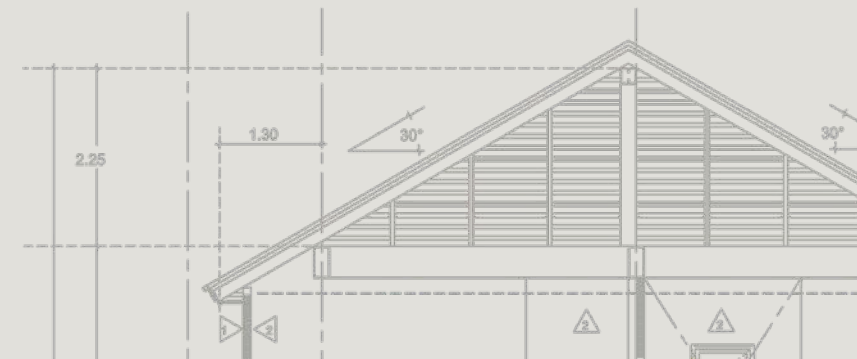

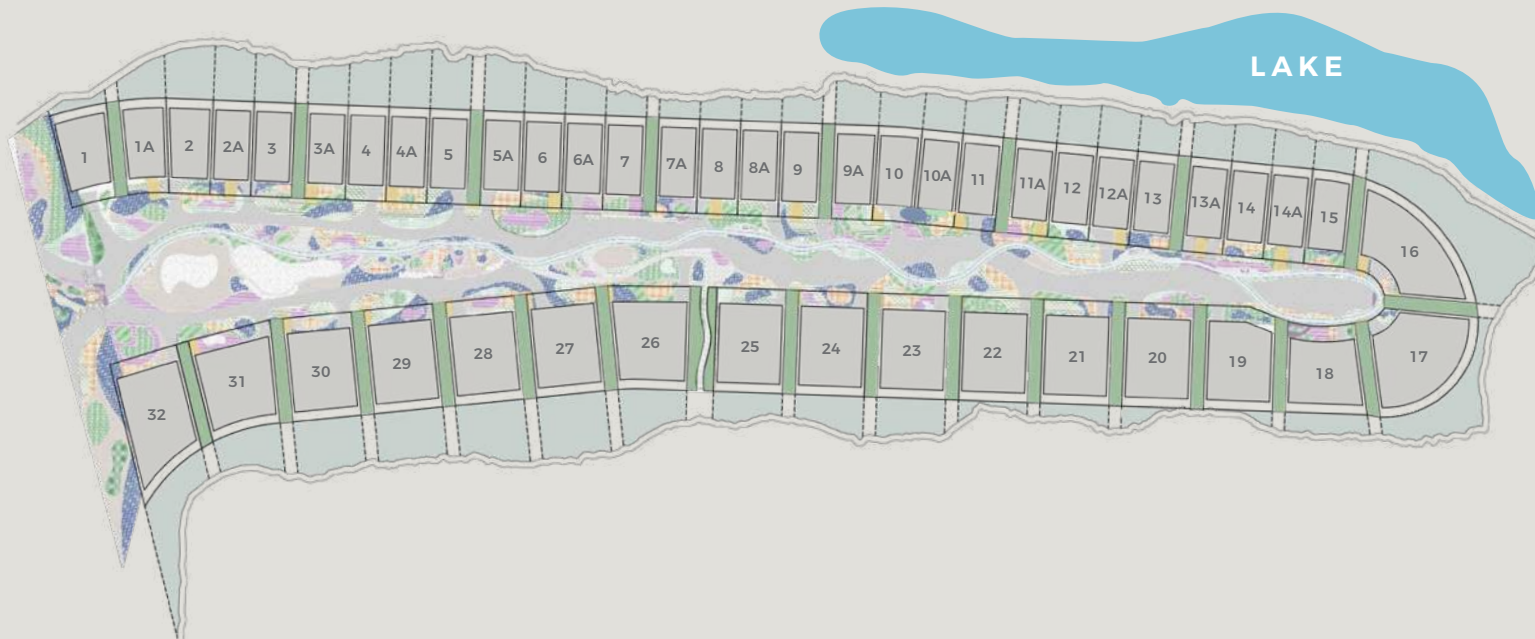

LOT	m <sup>2</sup>	COMMODATUM	TOTAL	LOT	m <sup>2</sup>	COMMODATUM	TOTAL	LOT	m <sup>2</sup>	COMMODATUM	TOTAL
1	493m <sup>2</sup>	54m <sup>2</sup>	546m <sup>2</sup>	9	390m <sup>2</sup>	107m <sup>2</sup>	497m <sup>2</sup>	18	669m <sup>2</sup>	166m <sup>2</sup>	836m <sup>2</sup>
1A	422m <sup>2</sup>	159m <sup>2</sup>	581m <sup>2</sup>	9A	404m <sup>2</sup>	179m <sup>2</sup>	583m <sup>2</sup>	19	714m <sup>2</sup>	31m <sup>2</sup>	745m <sup>2</sup>
2	422m <sup>2</sup>	252m <sup>2</sup>	674m <sup>2</sup>	10	404m <sup>2</sup>	146m <sup>2</sup>	550m <sup>2</sup>	20	726m <sup>2</sup>	61m <sup>2</sup>	787m <sup>2</sup>
2A	390m <sup>2</sup>	215m <sup>2</sup>	605m <sup>2</sup>	10A	390m <sup>2</sup>	144m <sup>2</sup>	534m <sup>2</sup>	21	726m <sup>2</sup>	98m <sup>2</sup>	824m <sup>2</sup>
3	390m <sup>2</sup>	181m <sup>2</sup>	571m <sup>2</sup>	11	390m <sup>2</sup>	152m <sup>2</sup>	542m <sup>2</sup>	22	726m <sup>2</sup>	57m <sup>2</sup>	783m <sup>2</sup>
3A	390m <sup>2</sup>	157m <sup>2</sup>	547m <sup>2</sup>	11A	390m <sup>2</sup>	161m <sup>2</sup>	551m <sup>2</sup>	23	726m <sup>2</sup>	251m <sup>2</sup>	977m <sup>2</sup>
4	390m <sup>2</sup>	187m <sup>2</sup>	577m <sup>2</sup>	12	390m <sup>2</sup>	162m <sup>2</sup>	552m <sup>2</sup>	24	726m <sup>2</sup>	219m <sup>2</sup>	946m <sup>2</sup>
4A	390m <sup>2</sup>	226m <sup>2</sup>	616m <sup>2</sup>	12A	390m <sup>2</sup>	163m <sup>2</sup>	553m <sup>2</sup>	25	726m <sup>2</sup>	180m <sup>2</sup>	906m <sup>2</sup>
5	390m <sup>2</sup>	218m <sup>2</sup>	608m <sup>2</sup>	13	390m <sup>2</sup>	137m <sup>2</sup>	527m <sup>2</sup>	26	794m <sup>2</sup>	277m <sup>2</sup>	1,071m <sup>2</sup>
5A	390m <sup>2</sup>	217m <sup>2</sup>	607m <sup>2</sup>	13A	390m <sup>2</sup>	146m <sup>2</sup>	536m <sup>2</sup>	27	726m <sup>2</sup>	427m <sup>2</sup>	1,154m <sup>2</sup>
6	390m <sup>2</sup>	167m <sup>2</sup>	557m <sup>2</sup>	14	390m <sup>2</sup>	153m <sup>2</sup>	543m <sup>2</sup>	28	726m <sup>2</sup>	390m <sup>2</sup>	1,117m <sup>2</sup>
6A	390m <sup>2</sup>	136m <sup>2</sup>	526m <sup>2</sup>	14A	390m <sup>2</sup>	137m <sup>2</sup>	527m <sup>2</sup>	29	726m <sup>2</sup>	335m <sup>2</sup>	1,062m <sup>2</sup>
7	390m <sup>2</sup>	252m <sup>2</sup>	485m <sup>2</sup>	15	390m <sup>2</sup>	115m <sup>2</sup>	505m <sup>2</sup>	30	726m <sup>2</sup>	358m <sup>2</sup>	1,085m <sup>2</sup>
7A	390m <sup>2</sup>	73m <sup>2</sup>	463m <sup>2</sup>	16	906m <sup>2</sup>	969m <sup>2</sup>	1,875m <sup>2</sup>	31	788m <sup>2</sup>	256m <sup>2</sup>	1,044m <sup>2</sup>
8	390m <sup>2</sup>	87m <sup>2</sup>	477m <sup>2</sup>	17	909m <sup>2</sup>	418m <sup>2</sup>	1,328m <sup>2</sup>	32	855m <sup>2</sup>	426m <sup>2</sup>	1,281m <sup>2</sup>

## AN EXCLUSIVE LIFE WITH UNMATCHED EXPERIENCES

At **La Escondida**, we take luxury and comfort to the next level with our exclusive concierge service. Enjoy personalized experiences with a private chef, waitstaff, and in-home mixology, or relax with the assistance of a butler, nanny, or the coordination of unique tours.

All our services are available by reservation and at an additional cost. Let us take care of every detail, so your only concern is to enjoy.



### BY RESERVATION

- Airport transfers and ground transportation.
- Tour bookings, excursions, spa services, and massages.
- Show ticket reservations.
- Dinner reservations.
- Babysitting, housekeeping, and private chef services.
- Laundry services.
- Housekeeping staff service.

## SIGNATURE ARCHITECTURE

At **La Escondida**, you have the opportunity to design your own residence or choose from two architectural projects created specifically to blend with the environment and lifestyle of this community.

Select from designs by some of Mexico's most renowned architecture firms:



Each of these projects has been thoughtfully designed to blend seamlessly with La Escondida's natural landscape, with careful attention to detail, elevated functionality, and the signature style of prestigious firms.

It's a secure and exceptional way to build your home, backed by experts in creating extraordinary spaces.

*\*Applies only to lots 16 to 32.*

# VIEWS OF LA ESCONDIDA

HOLE 7

HOLE 4

LA ESCONDIDA

HOLE 3





The images shown are for illustrative purposes only. The final product may vary and is subject to change without prior notice, based on the needs of the project and the developer.



The images shown are for illustrative purposes only. The final product may vary and is subject to change without prior notice, based on the needs of the project and the developer.



The images shown are for illustrative purposes only. The final product may vary and is subject to change without prior notice, based on the needs of the project and the developer.



The images shown are for illustrative purposes only. The final product may vary and is subject to change without prior notice, based on the needs of the project and the developer.



LA ESCONDIDA

HOLE 4

AS A RESIDENT OF LA ESCONDIDA, YOU'LL BE INVITED TO ACQUIRE AN EXCLUSIVE MEMBERSHIP THAT GRANTS YOU ACCESS TO ALL THESE EXCEPTIONAL EXPERIENCES.

An aerial photograph of a tropical beach club. In the center-left, there is a large, circular swimming pool with a smaller circular hot tub inside it. The pool is surrounded by a wooden deck and several lounge chairs. To the right of the pool, there is a sandy beach with more lounge chairs and white umbrellas. The beach is lined with numerous palm trees. In the background, there is a wooden deck area with more lounge chairs and umbrellas. The ocean is visible on the right side of the image, with clear, turquoise water. The overall scene is a luxurious and relaxing coastal oasis.

## IMMERSE YOURSELF IN A UNIQUE EXPERIENCE BEYOND A BEACH CLUB

Costa Beach Club is a coastal oasis where every detail is designed to delight your senses.

Enjoy our private beach access, where crystal-clear waters and soft sand invite you to relax and disconnect from the world.

You'll also enjoy a variety of restaurants, wellness activities, a rejuvenating spa, a modern gym, a fun kids club, and pools perfect for unwinding.

At Costa Beach Club, you'll experience a complete lifestyle that blends luxury, comfort, and fun in a paradisiacal setting.

**COSTA BEACH CLUB**

# Dive into the experiences of Costa Beach Club



- |                |                |                   |                  |                     |
|----------------|----------------|-------------------|------------------|---------------------|
| 1 Beach Pool   | 8 Cenote Pool  | 15 Wellness       | 22 Game Room     | 29 Handcraft Market |
| 2 Beach Access | 9 Yoga         | 16 Kids Pool      | 23 Pacific Pool  | 30 Art Gallery      |
| 3 Restaurant   | 10 Jungle Gym  | 17 Marketplace    | 24 Atlantic Pool | 31 Ballroom         |
| 4 Ancient Pool | 11 Gym         | 18 Boutique       | 25 Shops         | 32 Sun Pool         |
| 5 Candy Shop   | 12 Spa         | 19 Juice Bar      | 26 Restaurant    | 33 Plaza            |
| 6 Pizza Shop   | 13 Family Pool | 20 Ice Cream Shop | 27 Palm Court    | 34 Club House       |
| 7 Sushi Bar    | 14 Coffee Shop | 21 Playroom       | 28 Kids Club     | 35 Motor Lobby      |



## POOLS

Our pools invite you to dive into an oasis of tranquility, with spaces perfect for both swimming and relaxing.

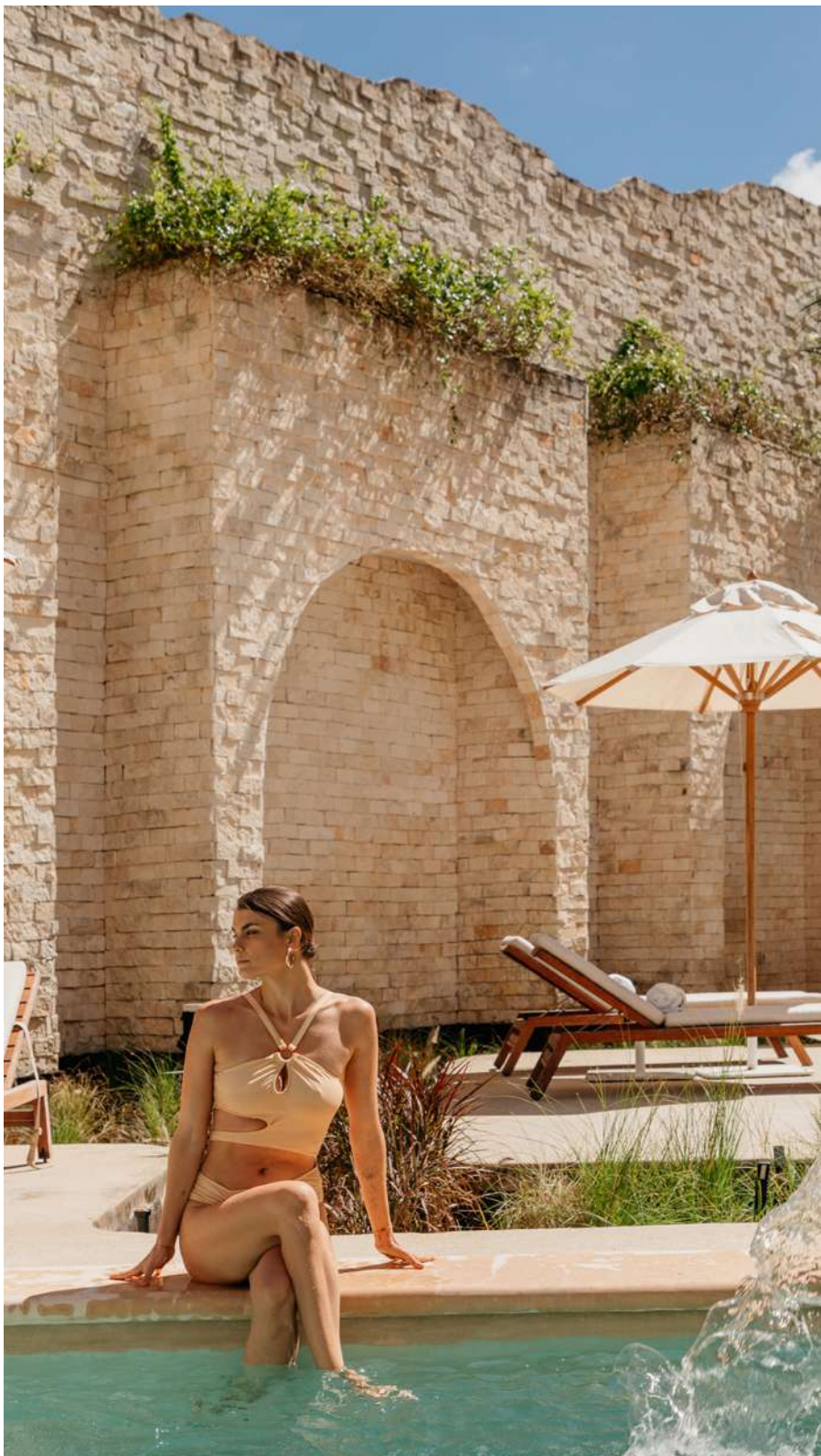





GYM

Channel your energy in the gym, fully equipped with technology to help you reach your fitness goals.

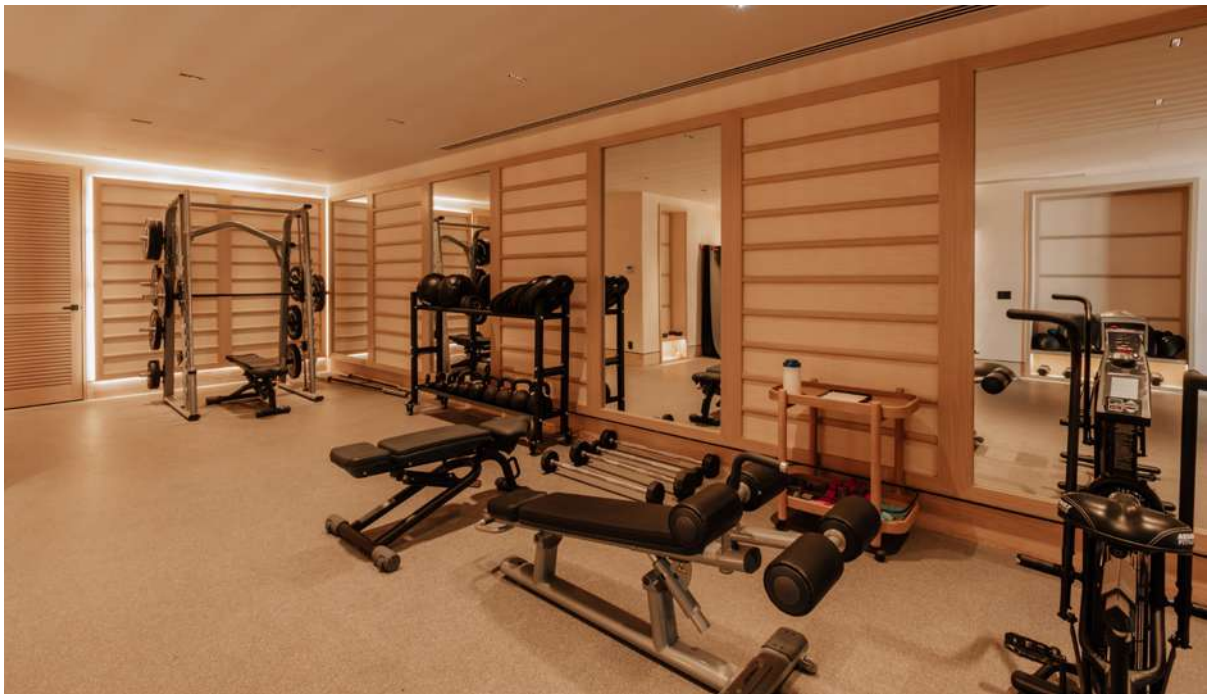



**SPA**

Connect with your well-being in our spa, a sanctuary of calm and relaxation designed to nurture both body and mind.



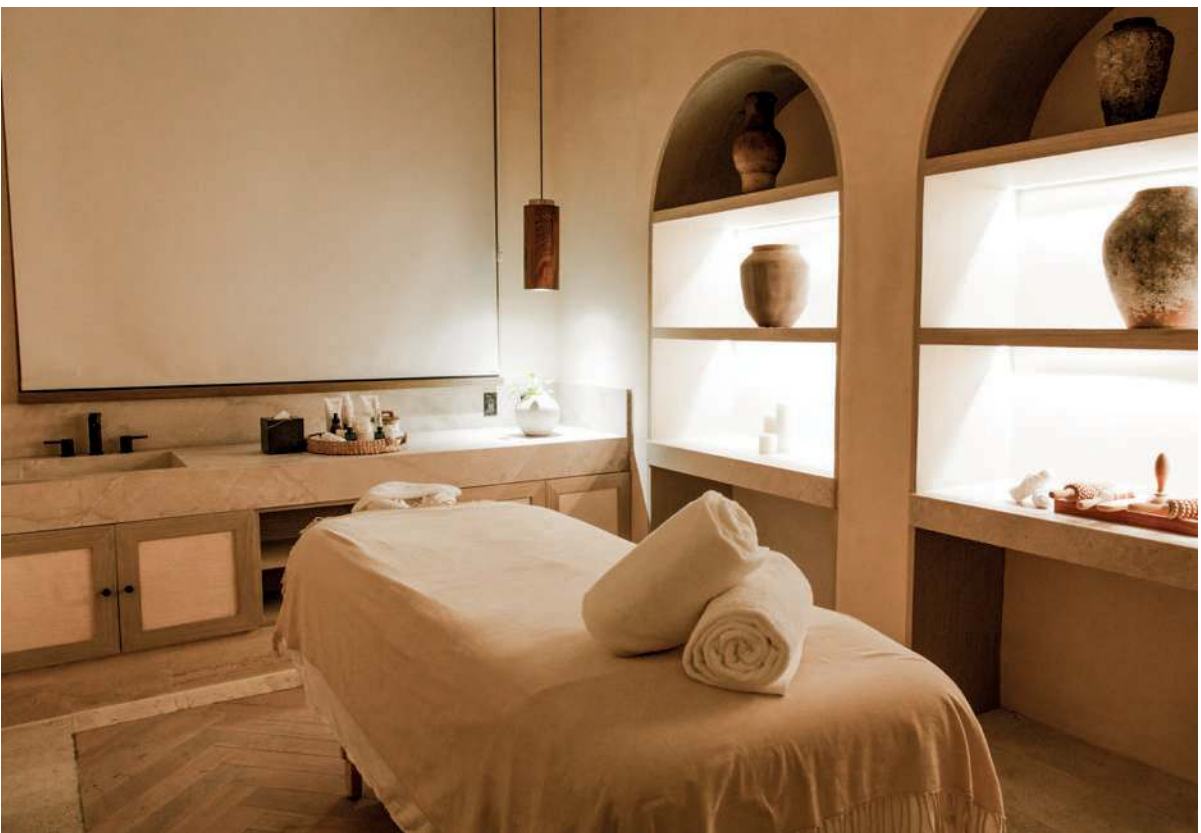





RESTAURANT

Enjoy a unique culinary experience at the restaurant, featuring a carefully curated menu designed to satisfy every taste.

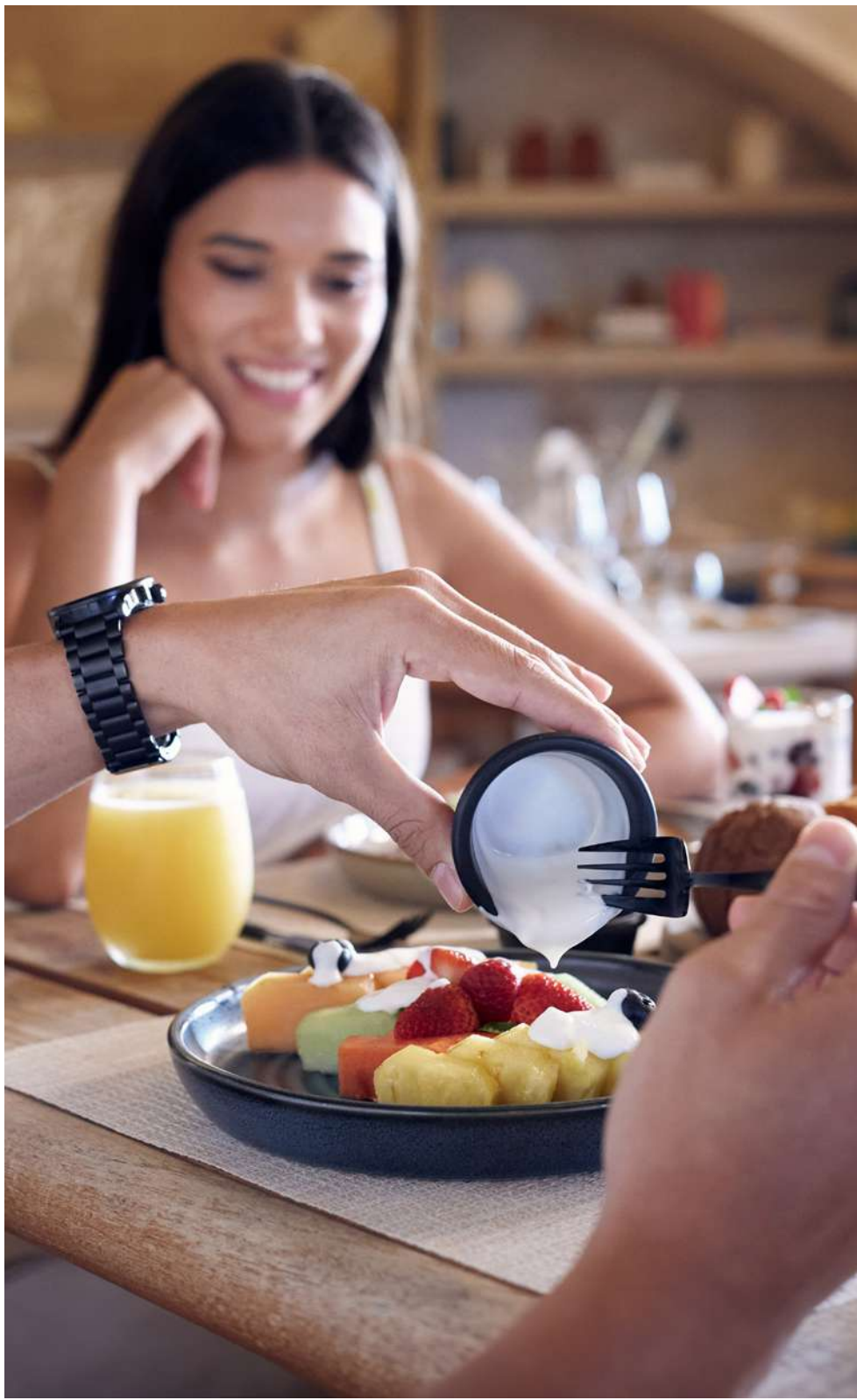





**PLAYROOM**

A place where fun and learning meet, the playroom is the ideal space for children to enjoy themselves and develop their skills.





# SUSHI BAR

Experience the pleasure of sushi, where premium ingredients and innovation come together to offer you the very best.

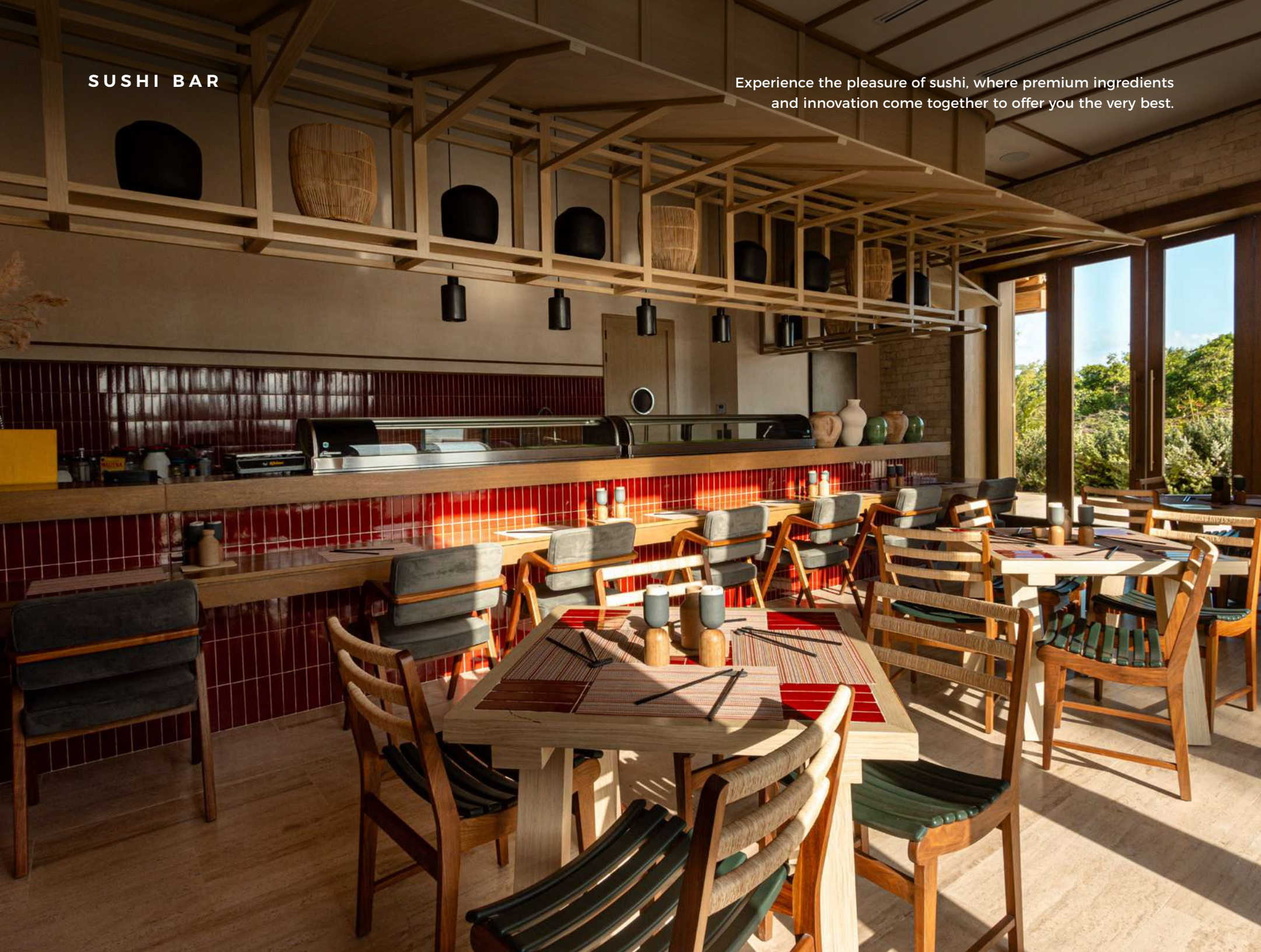







**PIZZA SHOP**

Delight your palate with the authentic flavor of our artisanal pizzas, crafted with fresh, top-quality ingredients.







MARKETPLACE

Find what you need at the marketplace, offering a wide variety of products and everyday essentials designed to suit your lifestyle.





LIVE THE CHALLENGE



GRAN COYOTE GOLF

**Gran Coyote** is a championship-style golf course designed by renowned golfer and Golf Hall of Fame member, **Nick Price**.



## AN UNFORGETTABLE GOLF EXPERIENCE IN THE RIVIERA MAYA

**Gran Coyote Golf** is an 18-hole, par-71 course meticulously designed to offer you an unforgettable playing experience. Each hole presents strategic and diverse challenges suited for all skill levels. Whether you're a seasoned pro or just starting out, this course will captivate you with its layout and exceptional practice facilities.

Designed by Golf Hall of Fame member **Nick Price**, this championship course will challenge your game while you enjoy breathtaking scenery and an unparalleled golfing experience.







THE PERFECT BLEND OF CHALLENGE, NATURE,  
AND GOLF IN THE RIVIERA MAYA.



THE PARK



The charm of **The Park** lies in its sports facilities surrounded by natural environments.

- 1 Access
- 2 Tennis court
- 3 Pickleball court
- 4 Padel court
- 5 Play area
- 6 Pump park
- 7 Water park
- 8 Batting cage
- 9 Basketball court
- 10 Parking lot



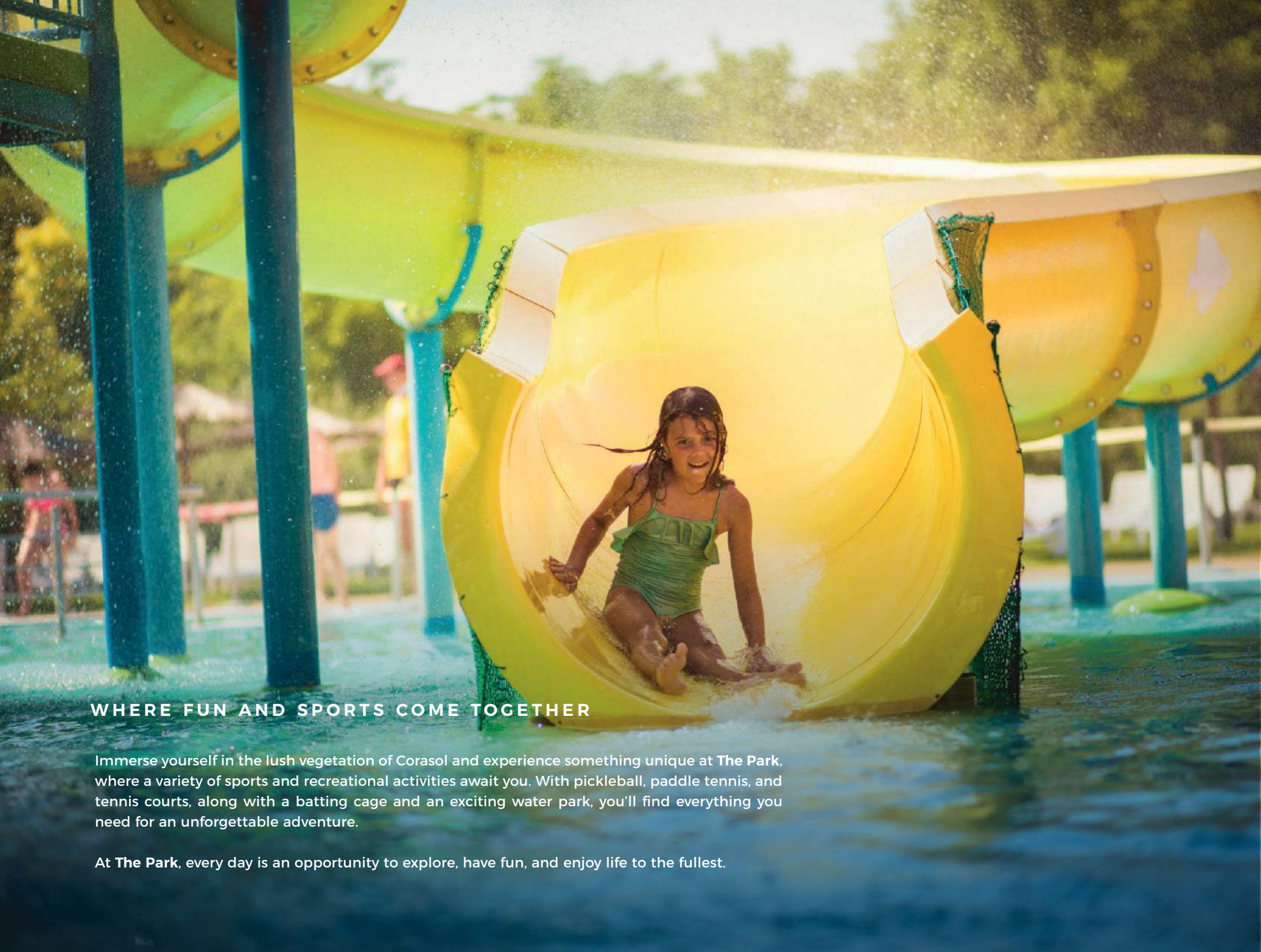

## WHERE FUN AND SPORTS COME TOGETHER

Immerse yourself in the lush vegetation of Corasol and experience something unique at **The Park**, where a variety of sports and recreational activities await you. With pickleball, paddle tennis, and tennis courts, along with a batting cage and an exciting water park, you'll find everything you need for an unforgettable adventure.

At **The Park**, every day is an opportunity to explore, have fun, and enjoy life to the fullest.

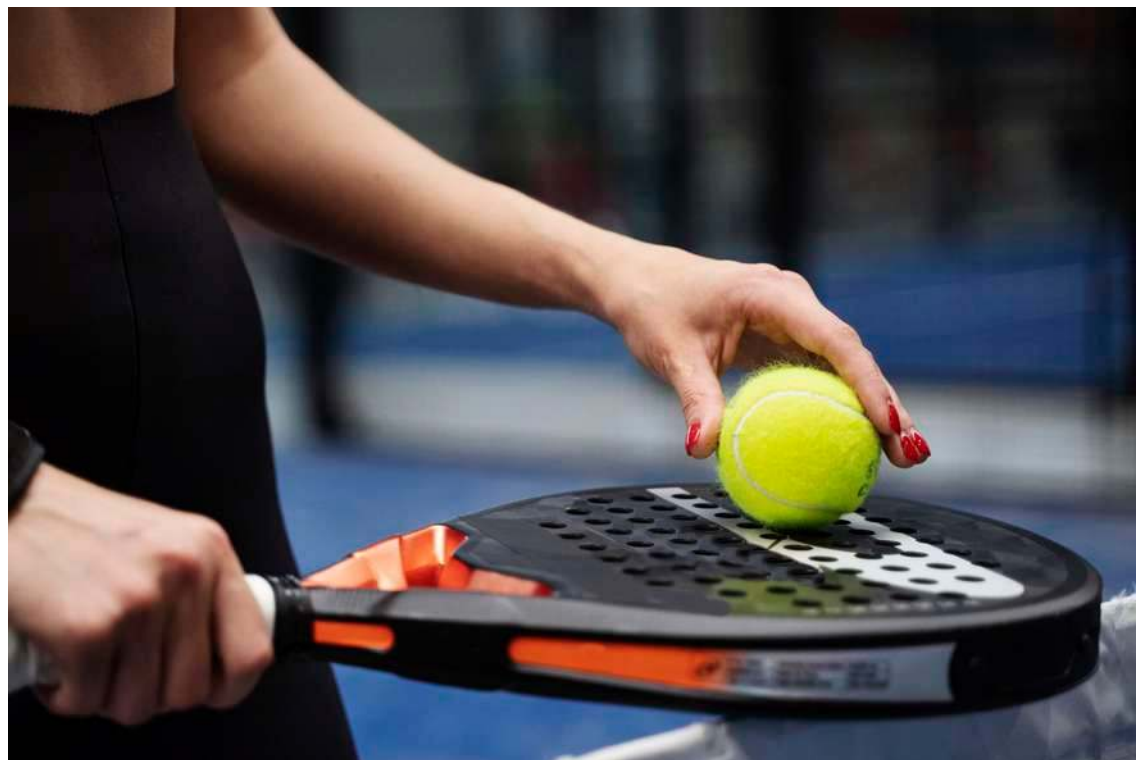



## PRESERVATION AND LIFE IN HARMONY WITH NATURE

Two spaces at the heart of **Corasol**, one designed for family life and the other pet-friendly, created for the enjoyment of the entire community.

These parks feature two cenote caves surrounded by native trees and vegetation, forming a wild and immersive natural landscape.



CENOTES PARK



## ORGANIC ORCHARDS



### FROM NATURE TO YOUR HOME

At **Corasol**, we care about a lifestyle focused on holistic well-being, which is why we created three different types of gardens aimed at connecting with nature:

- Landscape Gardens.
- Edible Gardens.
- Aromatic Gardens.

These spaces will host activities that promote knowledge about growing and consuming these plants, while encouraging a healthier and more conscious diet, fostering a connection with nature, and creating opportunities to strengthen the sense of community.

## DISCOVER OUR RESIDENTIAL COMMUNITY



### COSTA

RESIDENCES & BEACH CLUB

CORASOL, RIVIERA MAYA



### PALM VILLAS

ESTATE HOMES

CORASOL, RIVIERA MAYA



### THE VILLAGE

RESORT & RESIDENCES

CORASOL, RIVIERA MAYA



### LA ESCONDIDA

HIDDEN LAND

CORASOL, RIVIERA MAYA



### PUNTA LAGUNA

LUXURY CONDOS

CORASOL, RIVIERA MAYA



### EL AMATE

GOLF FRONT LOTS

CORASOL, RIVIERA MAYA



## WHY INVEST IN THE RIVIERA MAYA?

The Riviera Maya has experienced steady economic growth, with urban and tourism developments that increase property values year after year. Cities like Playa del Carmen have an average annual appreciation of **8% to 12%**, making it a solid market for investors.

### HOTEL OCCUPANCY IN THE RIVIERA MAYA

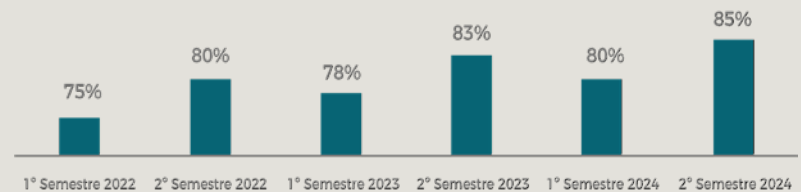

With over **20 million visitors annually**, the Riviera Maya is one of the most visited destinations in the world. This constant flow of tourists creates growing demand for accommodation, making vacation property investment a highly profitable opportunity. Platforms like **Airbnb** and **Booking** have further boosted this business model.

The Riviera Maya is attractive not only to tourists, but also to expats and digital nomads looking for a relaxed lifestyle, close to nature, with access to top-tier services. This trend has driven the long-term rental market and increased demand for developments with coworking spaces and modern amenities.

## AVERAGE CAPITAL GAINS IN REAL ESTATE

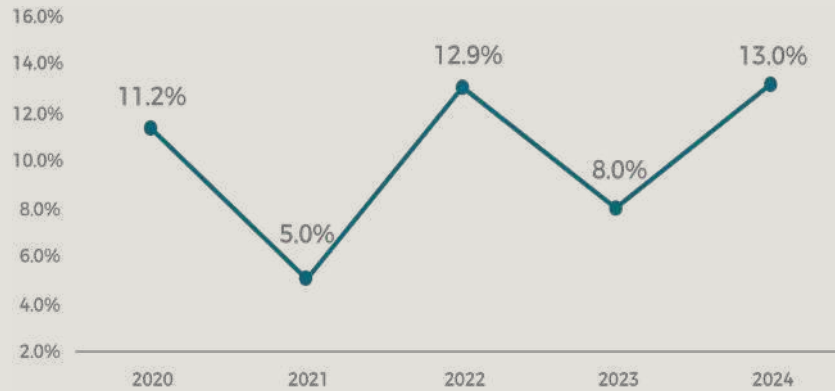

Investing in the **Riviera Maya** in 2025 represents a unique opportunity for those seeking financial stability, high returns, and guaranteed appreciation. With a constantly growing market, developing infrastructure, and unwavering tourist demand, the region stands out as one of the best places to invest in real estate in Latin America.

The Mexican Caribbean has air connections to a total of 124 cities around the world, including 2 countries in North America, 13 in Latin America, and 15 in Europe. In addition, the development of the **Maya Train**, the modernization of the **Cancun International Airport**, and the recent opening of the **Tulum Airport** have significantly strengthened the region's connectivity. These improvements not only boost economic growth but also increase tourist arrivals, directly benefiting the real estate sector.



4 HOURS

NEW YORK CITY

CHICAGO

DENVER

3 HOURS

UNITED STATES

LAS VEGAS

LOS ANGELES

PHOENIX

SAN DIEGO

DALLAS

2 HOURS

EL PASO

AUSTIN

HOUSTON

MIAMI

BAJA CALIFORNIA

1 HOUR

MEXICO

PUERTO VALLARTA

CANCUN

PLAYA DEL CARMEN

MEXICO CITY

ACAPULCO



## A JOURNEY TO THE GEM OF THE MEXICAN CARIBBEAN

The Riviera Maya has quickly become one of the most sought-after destinations in North America. Bordered by lush jungles and white sandy beaches on the Yucatan Peninsula, this enchanting paradise is also located minutes away from iconic archaeological attractions dating back to the Mayan civilization and UNESCO World Heritage sites.

### Nearby Attractions

---

**Xenses Theme Park**  
*14 km south*

**Xcaret Eco-Archaeological Park**  
*15 km south*

**Cozumel Coral Reef Monument**  
*30 km east*

**Xel-Há Water Theme Park**  
*53 km south*

**El Cielo Beach**  
*56 km east*

**Cancun Underwater  
Museum of Art**  
*60 km north*

**Tulum Beach, Restaurants,  
and Nightlife**  
*61 km south*

**Tulum National Park and  
Archaeological Site**  
*68 km south*

**Beaches and Beach Clubs  
of Isla Mujeres**  
*84 km north*

**Ancient Pyramids of  
Chichen Itza**  
*185 km east*

## GETTING TO CORASOL

**Cancun International Airport**  
*40 minutes*

**Playa del Carmen**  
*8 minutes*

**Xcaret Eco Water Park**  
*15 minutes*

**Tulum Beaches &  
Mayan Ruins**  
*50 minutes*

**Cenote Chaak Tun  
Underground Caves**  
*20 minutes*

**Coba Mayan Ruins**  
*1.5 hours*



Although Corasol feels like a world apart, getting here is easy. Cancun International Airport, just a 40-minute drive from Corasol, is served by all major airlines, many of which offer direct flights from key cities across the United States.





RIVIERA MAYA



CORASOL